

# LV105-HOOD

## AREA FLOOD LIGHT WITH HOOD

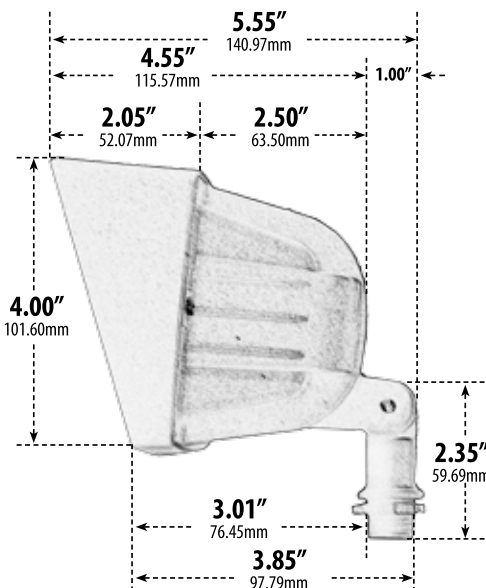
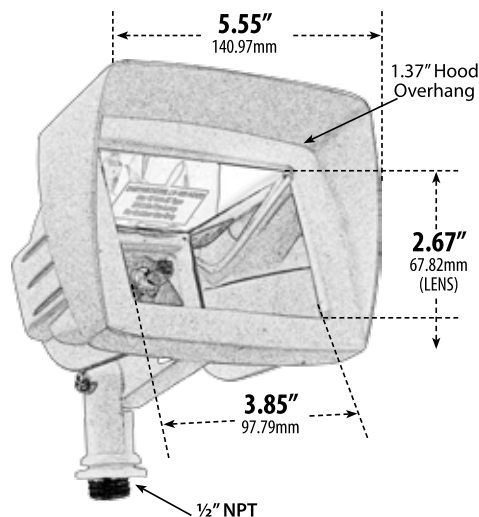

- ▶ **Material:** Powder Coated Cast Aluminum
- ▶ **Lens:** Clear, Heat Resistant, Tempered Glass
- ▶ **Lamp:** JC Bi-Pin Base (50W Maximum)

MODEL NUMBER	LAMP TYPE	ILLUMINANT TYPE	WATTS (W)	VOLTS (V)	LAMP(S) INCLUDED?
LV105-HOOD	JC	HALOGEN	20	12	YES
LV-LED105-HOOD	JC-LED	LED	2.5	12	YES

Pre-wired with UL Listed Direct Burial Wire/Cable

- ▶ **Adjustable Knuckle with 1/2" NPT**
- ▶ **Ground Spike Included for Installation**
- ▶ **Connector Available:** P-CN01 (sold separately)
- ▶ **Available Finish:** Black, White, Bronze, Green, Verde Green
- ▶ **ETL Approved**

Overall Dimensions: 6.00"H x 5.55"W x 5.55"D

Maximum Height: 6.00"

Minimum Height: 5.50"

Width: 5.55"

Maximum Depth: 5.50"

Minimum Depth: 4.00"

Weight: 1.0 lbs

Approximate Wire Length: 15.0"

Box Dimensions: 4.00"W x 8.25"H x 5.63"D

**DABMAR**  
LIGHTING

DABMAR LIGHTING INCORPORATED

2140 Eastman Ave . Oxnard, CA 93030 . 805.604.9090 . f: 805.604.9050 . www.dabmar.com