

Model No :: **31000LEDD-BS/OPL**
 Name :: Vail



Project Name :: _____
 Location :: _____
 Type :: _____
 Quantity :: _____
 Notes :: _____

Product Information

Product ID :: 31000
 UPC Code :: 641594185614
 Mounting Type :: Wall
 Finish :: Brushed Steel (BS)
 Diffuser :: Opal (OPL)

See Page 2 for Custom Product Options

Product Dimensions

Fixture		Canopy
Length ::	N/A	Length :: N/A
Width ::	25.5"	Width :: N/A
Diameter ::	N/A	Diameter :: N/A
Extension ::	3.25"	Height :: N/A
Height ::	4.25"	
Overall Height ::	N/A	



Technical Specifications

Qualifications

Location Rating :: Wall
 Certification :: cULus
 IES File :: Yes
 Title 24 :: Yes
 Energy Star :: Yes
 ADA Compliant :: Yes
 Marine Grade :: No
 Emergency Lighting :: No
 Warranty :: 5 Year
 Manufacture

Specifications

Frame Material :: Metal
 Diffuser Material :: N/A
 Lamping Type :: N/A
 Lamping Base :: SSL
 Lamp Quantity :: 1
 Lamp Wattage :: 26 W
 Total Wattage :: 26 W
 Lamps Included :: Yes
 J-Box Type :: Standard 4

Voltage

Voltage :: 120v

Photometrics

CCT :: 3000K
 CRI :: 90
 Wattage :: 26
 Nominal Lumens :: 3040
 Delivered Lumens :: N/A

Recommended Dimmers

(ELV) LUTRON Diva DVELV-300P; (ELV) LUTRON Diva DVELV-303P; (ELV) LUTRON Skylark SELV-300P; (TRIAC) LUTRON Diva DV-600P

Line Drawing #1

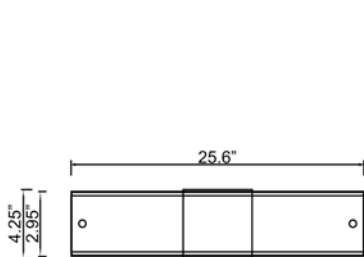

Line Drawing #2

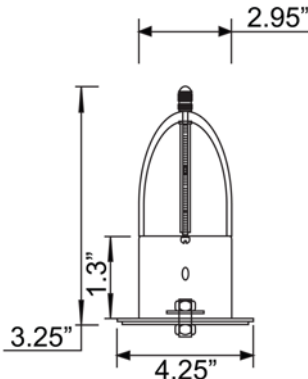

IES File

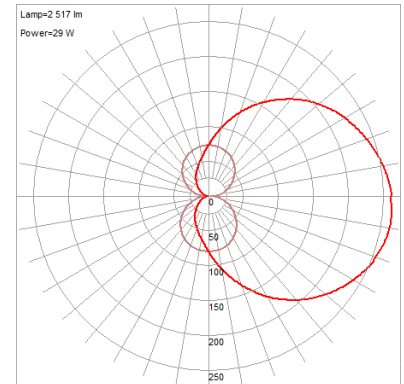

Toll Free 800-828-5483 or www.AccessLighting.com

14410 Myford Road, Irvine, CA 92606

The information provided is subject to change without notice. ©2018 Access Lighting Corporation. All Rights Reserved
 Rev. 4/6/2018 Filename: 31000LEDD-BS_OPL.pdf

