



INSTALLATION INSTRUCTIONS

IMPORTANT

Before assembling your ACCESS LIGHTING fixture, please make sure that you carefully read through this instruction sheet. Consider having your fixture installed by a qualified licensed electrician.

NOTE: The important safeguards and instructions that appear in this manual are not meant to cover all possible conditions and situations that may occur. It must be understood that common sense, caution and care, are factors that can't be built into any product. These factors must be supplied by the person(s) caring for and operating the fixture.

GENERAL INFORMATION

All electrical connections must be in accordance with all ordinances, Local and National Electrical Codes. These fixtures are intended for mounting to a standard 4" x 2 1/2" metal octagon outlet box. The box must be directly supported by the building structure and U.L. Recognized.

STEP BY STEP INSTRUCTIONS

Before starting your installation disconnect the Power by turning off the Circuit Breaker or by removing the fuse at the fuse box. Just turning the light off at the light switch is not sufficient to prevent electrical shock.

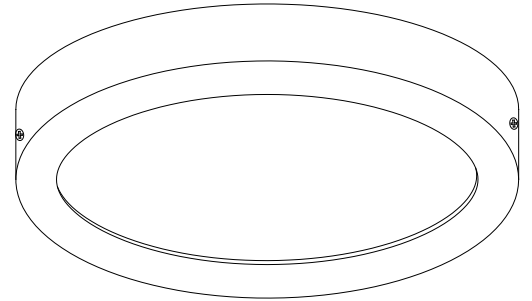

COLLECTION
STRIKE 2.0

APPLICATION
Wall/Ceiling

MODEL NO.
20800LEDD
20801LEDD

WHAT WE PROVIDE

- Crossbar
- Mounting Hardware
- LED

WHAT YOU NEED

- Screwdriver
- Wire Cutters
- Wiring Supplies as Specified by Electrical Code

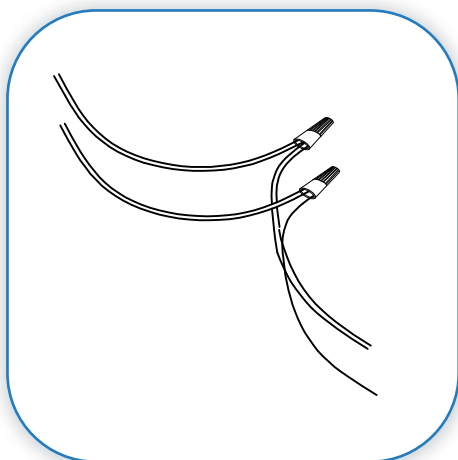

PREPARE FIXTURE AND CONNECT THE WIRES

If there is an existing fixture remove it.

Expose the supply wire from the junction box .

Connect the black supply wire to the black fixture wire.

Secure with the supplied wire nuts. Connect the white supply

wires to the white fixture wire. Secure with the supplied wire

nuts. Either wrap the green wire around one of the

protruding screws or connect it to the supply ground wire.

Secure all wires with U.L. Certified electrical tape (not

supplied). Tuck all wires carefully into the J-Box.

1

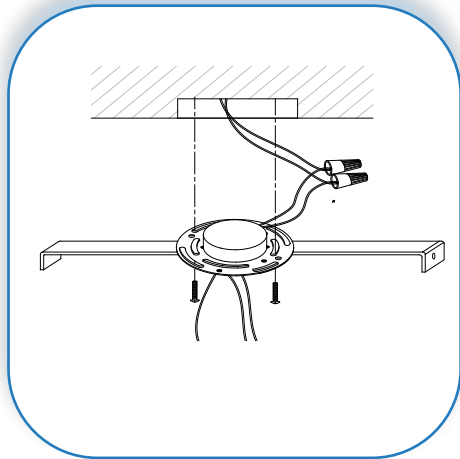

2

MOUNT THE CROSSBAR

Mount the crossbar to the J-box with the supplied screws.

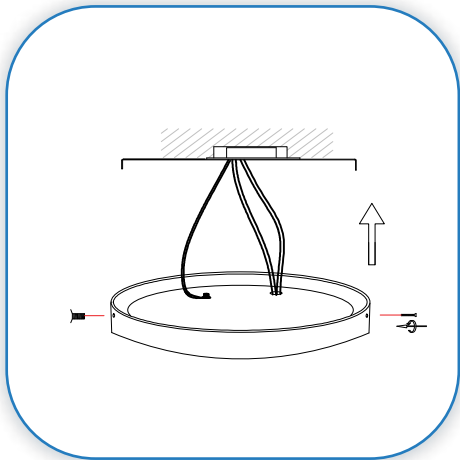

3

MOUNT THE FIXTURE

Fit the fixture canopy up to the crossbar. Align the holes in the sides of the crossbar with the designated holes in the canopy. Secure with the supplied screws.

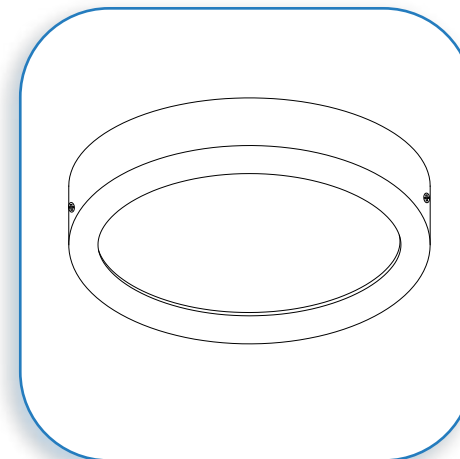

4

RESTORE THE ELECTRICITY AND CHECK THE OPERATION OF YOUR NEW ACCESS LIGHTING FIXTURE

CAUTION If the fixture is to be removed or replaced, please ensure that the electricity is switched off and that the fitting is cool before touching it.