

# EASY INSTALLATION INSTRUCTIONS FOR INSTALLING YOUR ENTRANCE HANDLE SET

UPPER BORE 2-1/8" DIAMETER HOLE  
LOWER BORE 2-1/8" DIAMETER HOLE

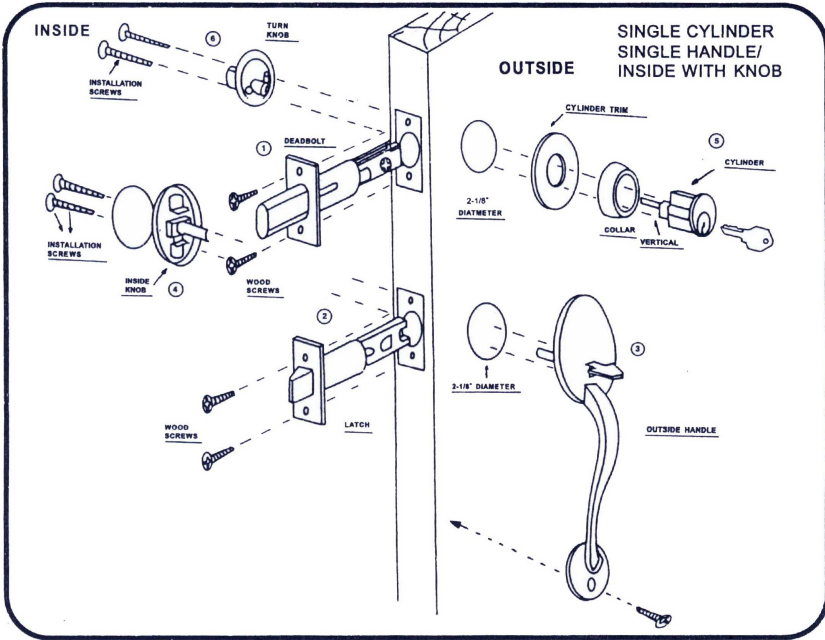

## INSTRUCTIONS FOR ADJUSTING LATCH FROM 2-3/8" (60mm) TO 2-3/4" (70mm). RETRACT LATCH BEFORE ADJUSTING SIZE

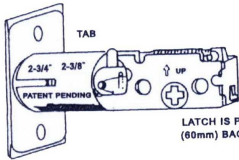

LATCH IS PRE-SET FOR 2-3/8" (60mm) BACKSET.

TO ADJUST FOR 2-3/4" (70MM) BACKSET  
ROTATE TAB CLOCKWISE TO DOWN POSITION AS SHOWN IN FIGURE B  
LATCH IS NOW ADJUSTED TO 2-3/4" POSITION. (70mm)

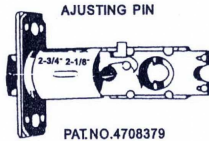
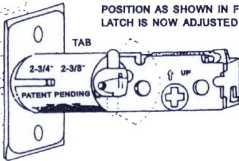

INSTRUCTIONS FOR ADJUSTING ENTRY LOCK LATCH.

1. LATCH IS PRE-SET FOR 2-3/8" (60mm) BACKSET.

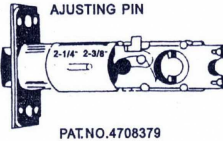

2. TO ADJUST FOR 2-3/4" (70mm) PUSH DOWN ON ADJUSTING PIN AND PULL. WHEN EXTENDED, LATCH NOW SET FOR 2-3/4" (70mm) BACKSET.

THE LOCK HAS BEEN ASSEMBLED TO FIT DOORS THAT WHEN FACING THE DOOR FROM THE OUTSIDE THE HINGES ARE ON THE LEFT. IF YOUR DOOR HAS THE HINGES ON THE RIGHT SIDE OF THE DOOR WHEN FACING THE DOOR FROM OUTSIDE. SEE ILLUSTRATIONS BELOW FOR INSTRUCTIONS TO TURN THE HALF ROUND TAILPIECE TO THE PROPER POSITION.

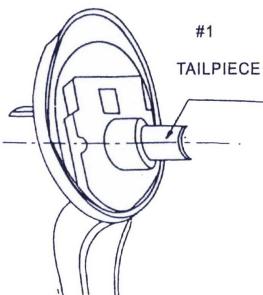

TAILPIECE FIXED FOR DOORS THAT HAVE HINGES ON LEFT SIDE WHEN FACING DOOR FROM OUTSIDE.

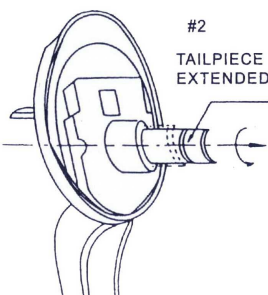

HOLD AND PULL TAILPIECE AND TURN 180° DEGREES COUNTER CLOCKWISE THEN RELEASE BACK INTO LOCK.

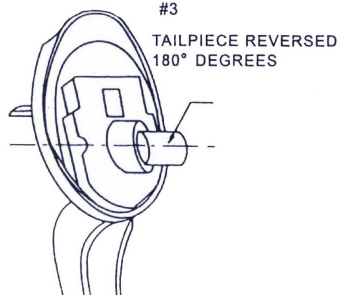

TAILPIECE NOW IN PROPER POSITION FOR INSTALLATION OF DOORS THAT HAVE HINGES ON THE RIGHT SIDE WHEN FACING DOOR FROM OUTSIDE.